

Scheda Tecnico Illustrativa Madia

Serie "Diko"



Immagine identificativa del prodotto nelle varie versioni disponibili

DESCRIZIONI TECNICHE:

Struttura - zoccoli - ripiani - top: Pannelli in particelle di legno, in fibra di legno, o tamburati, rivestiti in materiale melaminico, carta laccabile, in PVC e impiallacciati in tutte le essenze previste a listino.

Ripiani vetro: Ripiano in vetro sp.8mm con 4 lati filo lucido.

COMPOSIZIONE STRUTTURA:

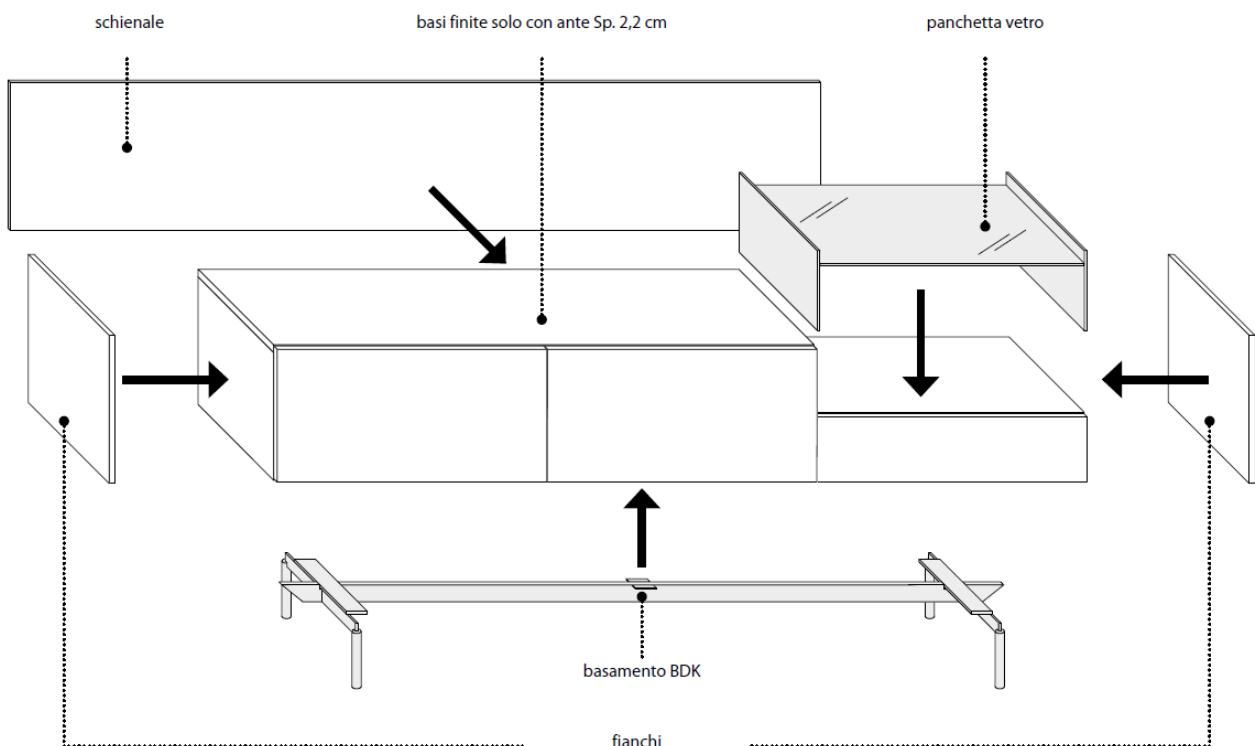

DIMENSIONI STANDARD MADIA:

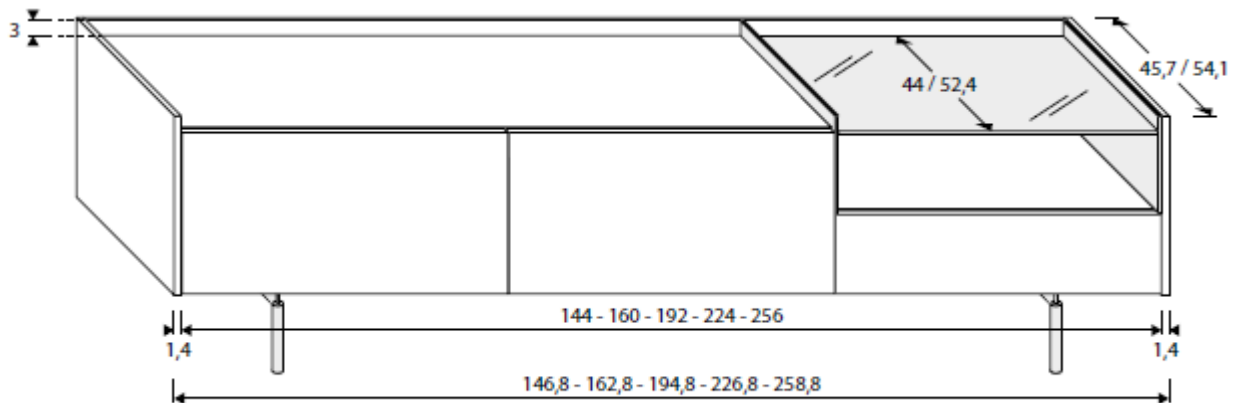

DIMENSIONI VANO A GIORNO CON PANCHETTA IN VETRO TRASPARENTE

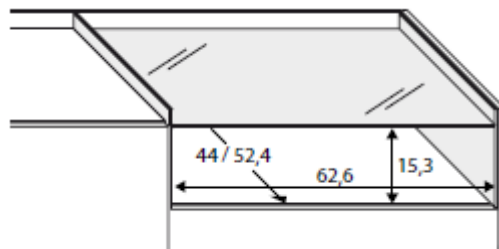

FINITURE STRUTTURA ESTERNA E FRONTALI

NOBILITATO LISCIO:

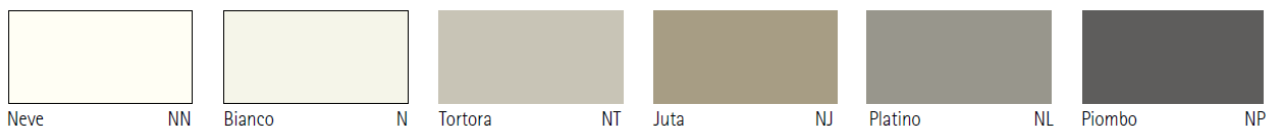

NOBILITATO OLD:



NOBILITATO ROVERE:

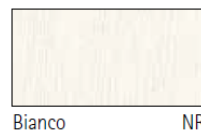

NOBILITATO QUERCIA:



NOBILITATO:



NOBILITATO EUKALIPTO:



NOBILITATO NOCE:



NOBILITATO ROSATO:



NOBILITATO TESSUTO:

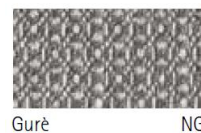

NOBILITATO METAL SMOKE



FASHION WOOD:



ROVERI LACCATI OPACHI:



LACCATI OPACHI E LUCIDI:

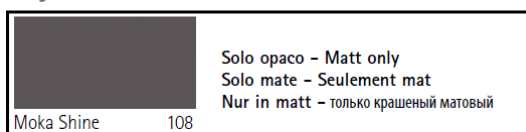
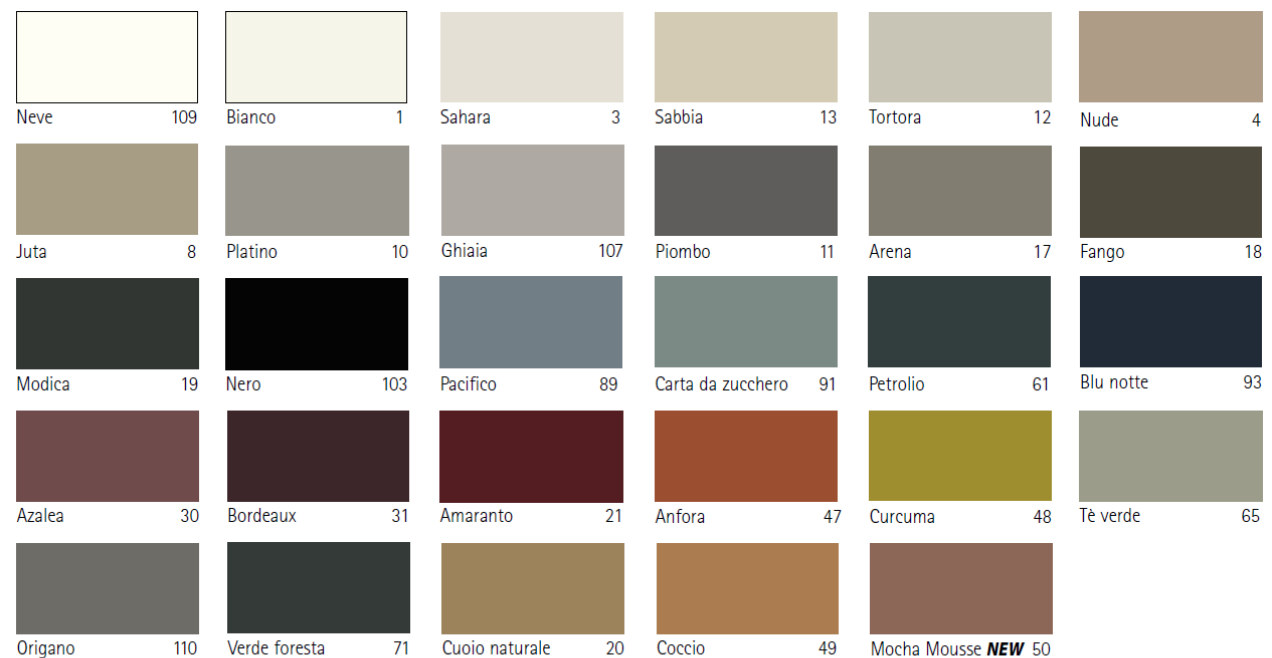

LACCATI OPACHI E LUCIDI:



FINITURE FRONTALI

GROOVE:



Noce Naturale 030G



Noce Classico 031G



Fashion wood Rovere
Naturale 014G



Fashion wood Rovere
Canapa 019G



Fashion wood Rovere
Biscotto 025G



Fashion wood Rovere
Terra 017G



Fashion wood Rovere
Ghiro 029G



Fashion wood Rovere
Carbone 018G



Fashion wood Rovere
Fossile 027G

FINITURA SCHIENA



Decor Tortora

FINITURE BASAMENTO IN METALLO



Moka Shine



Nickel



Dettaglio basamento (frontale finitura Groove)

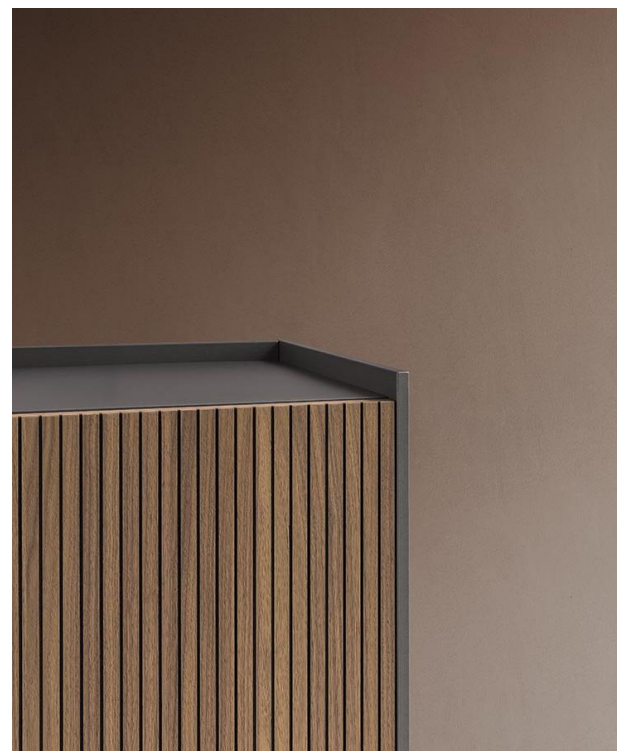

Dettaglio top (frontale finitura Groove)